

User Guide

Account Barcode Unsorted



Contents

User Guide (pages 2 – 9)

Introduction

Key product features

Product options at a glance

Existing products and corresponding new products

How to apply

How to produce mail pieces

How to post

Billing and adjustments

Further help

Appendices:

- 1 Printed Postage Impression including barcode indicia specification
- 1a. Printed Postage Impression with separate barcode indicia specification
- 2. Clear addressing and mail piece guide
- 3. Polymer envelopes and poly wrap guidelines

Introduction

Thousands of our customers enjoy the ease and convenience of handing us their letters and large letters to sort and they pay our standard tariff price to reflect the work we do to sort their mail before we can deliver it.

If you are one of these customers, you can save money by moving to our new account mail products – they are priced below our standard price – simply by displaying a barcode and a printed postage impression on your envelope.

To take advantage of the new product and the cost saving, you will first need to apply and accept our terms and conditions and once we've updated your online business account, you can print the postage impression including your barcode on your envelopes and record your posting details on an online business account sales order. No mail accreditation process is required to use account mail products.



Key product features

- You can post from 1 item.
- Letter and large letter formats.
- 1st Class and 2nd Class delivery speeds.
- No sortation of mail required – mail is unsorted.
- A high-quality barcode must be printed on all mail pieces.
- All items must be placed in trays or bags before posting.
- All items must be correctly recorded on an online business sales order that is confirmed on the day of posting.
- Sales orders will be billed at the current rate card prices.
- We will bill at the current rate card prices for any volume variances between the weekly totals recorded on your sales orders and the volumes received by Royal Mail or read by Royal Mail's automation.

Product options at a glance

| Type of mail | Minimum posting volume per class per sales order | Product options | VAT status |
|---|--|---|------------------------------|
| General correspondence, transactional or relationship communications. Customers can also send advertising mail with these products | 1 | Business Mail Account Unsorted or Account Mail Unsorted | VAT applicable VAT exempt |
| Mailings with the purpose of promoting the sale or use of products or services, or to encourage contribution to, or support a cause. | 1,000 Letters or 250 Large Letters | Advertising Mail Account Unsorted | VAT applicable |

Existing products and corresponding new products and product codes

Use the new product codes in the table below when completing an online business accounting sales order for your account posting.

| Existing product | Existing product code | New account product | New product code |
|---|-----------------------|--------------------------------------|------------------|
| Business Mail Unsorted 1 st Class | STL | Business Mail Account 1C Unsorted | UNA |
| Business Mail Unsorted 2 nd Class | STL | Business Mail Account 2C Unsorted | UNB |
| 1 st Class Account | BPL | Account Mail Unsorted 1C | UNG |
| 2 nd Class Account | BPL | Account Mail Unsorted 2C | UNH |
| Advertising Mail Unsorted 1 st Class | CLN | Advertising Mail Account 1C Unsorted | UNC |
| Advertising Mail Unsorted 2 nd Class | CLN | Advertising Mail Account 2C Unsorted | UND |



How to get started

To register your interest in our account mail product visit www.royalmail.com/barcodesavings to submit your details.

Please note the Account and Advanced products cannot be used on the same Royal Mail account.

Mail piece production

Mail piece sizes:

Letter items minimum size is 140mm x 110mm x 0.25mm

Letter items maximum size is 240mm x 165mm x 5mm

Large letters maximum size is 353mm x 250mm x 25mm

Letter maximum weight is 100g

Large letter maximum weight is 750g

Indicia & Barcode Options

Two options are available :-

1. Printed Postage Impression including barcode.
2. Printed Postage Impression with separate barcode.

Account Barcode Unsorted Indicia Option 1 - Printed Postage Impression including barcode

This option provides a printed postage impression that incorporates a 4-state barcode within the indicia. Print the printed postage impression including barcode in the top right corner of the mail piece in an area 75mm in length and 40mm in depth as illustrated below.

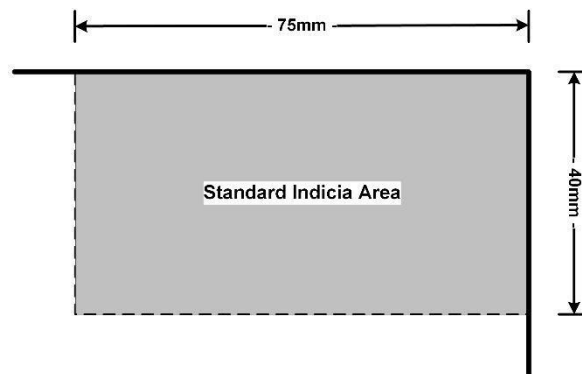

Please find below the dimensions for a 1st class English design and 2nd Class bi-lingual Welsh / English design of printed postage impression including barcode. The full specifications for all the printed postage impressions including barcodes are in appendix 1 at the end of this user guide.



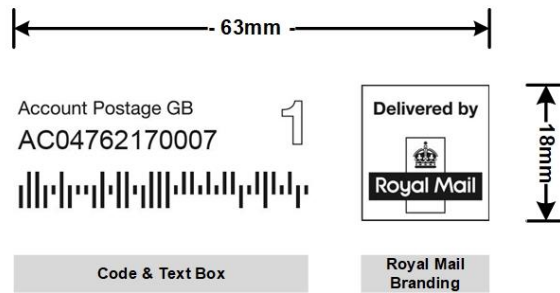

1st Class English printed postage impression including barcode

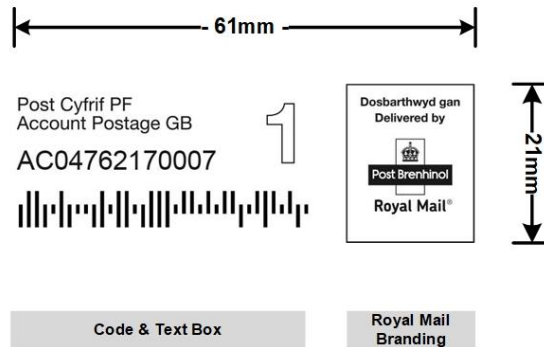

2nd Class Welsh printed postage impression including barcode

Option 1 - Help producing your mail pieces

To assist you with the production of your mail pieces we have developed an artwork generator at www.royalmail.com/artwork

To access the artwork generator please use the password you provided when setting up your account product. The artwork generator provides 2 file outputs:

1. EPS Vector for use by professional printers. EPS Vector is the recommended output to support high quality printing and efficient delivery and billing of your mail.
2. JPeg outputs.

The finished mail piece will look like this :-

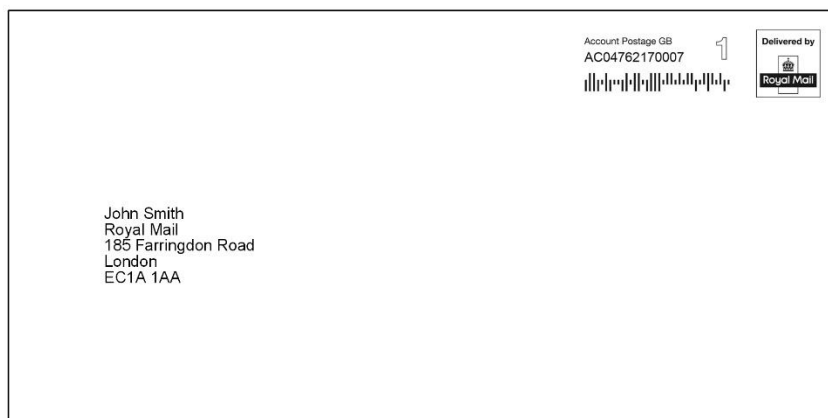

Account Barcode Unsorted Indicia Option 2 - Printed Postage Impression with separate barcode
 This option utilises a standard printed postage impression together with a separate Unsorted 4-state barcode. Print the printed postage impression in the top right corner of the mail piece in an area 75mm / 103mm in length and 40mm in depth as illustrated below, and the separate Unsorted 4-state barcode in the window of an envelope adjacent to the delivery address. (The Unsorted 4-state barcode being extracted from a printed postage impression including barcode.)

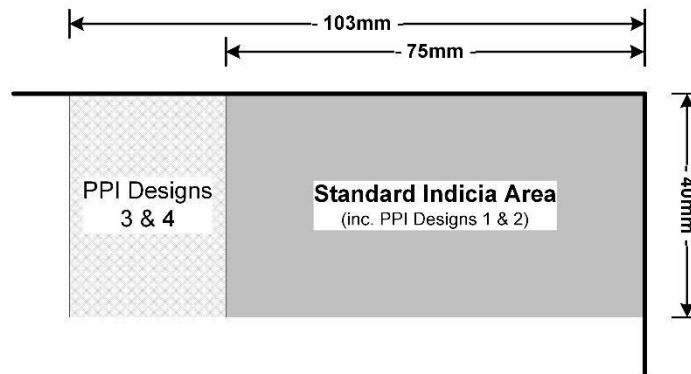

Please find below example illustrations for a 1st class English design and 2nd Class bi-lingual Welsh / English design of printed postage impression. Full details are provided at www.royalmail.com/ppi. The full specifications for the barcodes are in appendix 1 at the end of this user guide.



1st Class English printed postage impression



2nd Class Welsh printed postage impression



4-State Barcode



Option 2 - Help producing your mail pieces

To assist you with the production of your mail pieces we have developed artwork generators:-

- PPI artwork generators at <https://www.royalmail.com/produce-ppi>
- Unsorted artwork generators at www.royalmail.com/artwork

To access the Unsorted artwork generator please use the password you provided when setting up your account product. The Unsorted artwork generator provides 2 file outputs:

1. EPS Vector for use by professional printers. EPS Vector is the recommended output to support high quality printing and efficient delivery and billing of your mail.
2. JPEg outputs.

The finished mail piece with the printed postage impression with separate barcode shall be laid out like this:-

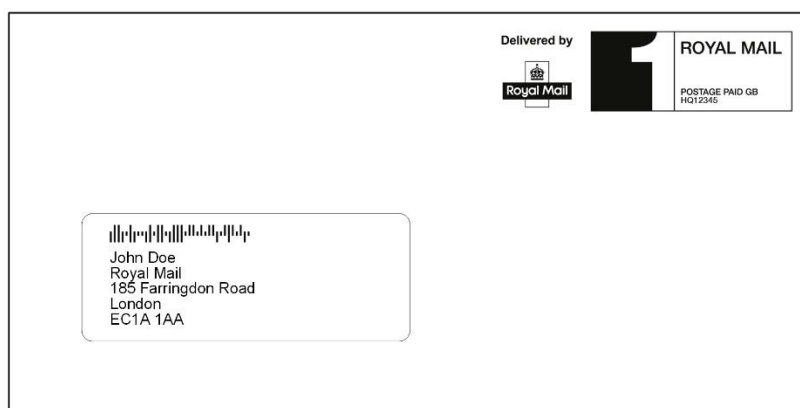

Mail piece material, colour and addresses

Letters (and inserts) should be paper based and white or cream colour envelopes to provide the best background for Royal Mail's machines to process and bill. Polymer envelope and poly wrap can be used for Large Letters provided the specifications in appendix 3 are met. Jiffy bags must not be used, and fulfilment goods items must not be sent by Business Mail or Advertising Mail Account products. Fulfilment goods items should be sent by Click and Drop or Parcel products.

<https://www.royalmail.com/business/parcels>

For full details on mail piece and address specifications please refer to the clear addressing guide in appendix 2 at the end of this user guide.

Posting your letters and large letters

To post your letters and large letters please place 1st class and 2nd class items in separate trays or bags and apply a label noting the product, class and format you are posting.

Trays are the recommended containers because they support maintaining the quality of your mail and efficient processing and delivery of your mail.

Letter items should be placed in trays upside down with the address facing the front of the tray.

Large Letters should be placed in the tray with the address facing upwards, and with the Indicia away from the tray barcode and label for landscape mail and with the Indicia adjacent to the tray barcode and label for portrait mail.

The weight of a tray must not exceed 10kg and the weight of a bag must not exceed 11kg.



Sales Order completion

You must record the details of each of your postings on an online business accounting sales order.

You can log in to online business accounting at www.royalmail.com/oba.

The web page contains a training video to help you complete an online business accounting sales order, the emergency posting process in case you cannot access the system and information on your invoices.

Posting your mail

You can have your mail collected by Royal Mail or take your mail to an approved acceptance point. For further details on our collection service or to book a collection please go to www.royalmail.com/collections.

Billing and adjustments

The details you record on your on-line business accounting sales orders will be billed at the published rate card prices that may include volume related discounts. Each week for postings Monday to Saturday you may be retrospectively billed for any volume variances between the weekly totals recorded on your sales orders and the volumes received by Royal Mail. Please see our rate cards for the published adjustment fees. Any such adjustments will appear on your invoice(s) with the following descriptions:

| Type of adjustment | Format | Class | Description on invoice |
|--|---------------------------|-----------------|--|
| Items with no barcode read | Letter | 1 st | Barcode not seen letter 1c |
| Items with no barcode read | Letter | 2 nd | Barcode not seen letter 2c |
| Items with no barcode read | Large Letter | 1 st | Barcode not seen large letter 1c |
| Items with no barcode read | Large Letter | 2 nd | Barcode not seen large letter 2c |
| Items not declared on Sales Orders | Letter | 1 st | Letters undeclared 1c |
| Items not declared on Sales Orders | Letter | 2 nd | Letters undeclared 2c |
| Items not declared on Sales Orders | Large Letter | 1 st | Large letters undeclared 1c |
| Items not declared on Sales Orders | Large Letter | 2 nd | Large letters undeclared 1c |
| Out of spec (product is Letter and Large Letter only) | Parcel | NA | Incorrect Format-LL = P (T) |
| Items not declared on Sales Orders (International destinations) | Letter or Large Letter | NA | Intl letter undeclared Intl large letter undeclared |

Adjustments for account mail VAT Exempt postings will have VAT E at the end of the description on your invoice for items with no barcode read and items not declared on Sales Orders.



Further help

For further assistance on completing your sales orders, understanding your invoices, requesting copy invoices and raising enquiries please visit our help pages below.

Online Business Accounting Help:

https://business.help.royalmail.com/app/answers/detail/a_id/869/kw/

Invoice enquiries:

www.royalmail.com/myaccount

You can also contact your usual service contact or call us on 03457 950 950.



Appendices

Appendix 1 - Printed Postage Impression including barcode indicia specification

Introduction

The designs in this specification are to be used with the unsorted Account product. Artwork for the product can be obtained at www.royalmail.com/artwork.

Purpose

The section specifies requirements for the printed postage impression including barcode indicia designs. They feature a Royal Mail Branding Mark surrounded by a border, with text and a code content to the left of the Mark.

Each design includes the following elements:-

- Account Postage Text
- Account Number
- Service Indicator
- Mailmark 4-State Barcode
- Royal Mail Branding Mark in English or Bi-Lingual Welsh / English surrounded by a border

Scope

- 1st & 2nd Class designs are required together with Bi-Lingual Welsh / English variants.
- The designs will be printed onto the mail piece either by customers or by their suppliers.
- Typically, the designs replace the standard PPI indicia. They may also be used with standard PPI indicia; the barcode from the Unsorted PPI design being located within the envelope window (see Appendix 1a).
- The option to apply the indicia using a Handstamp is not permitted.
- Scaling of the designs is not permitted.

Indicia Location

The Printed Postage Impression including barcode indicia designs (and their associated clear zones) must be wholly positioned in the top right corner of the mail piece in an area 75mm long and 40mm high.

A minimum clear zone of 5mm is required around the indicia design on all sides.

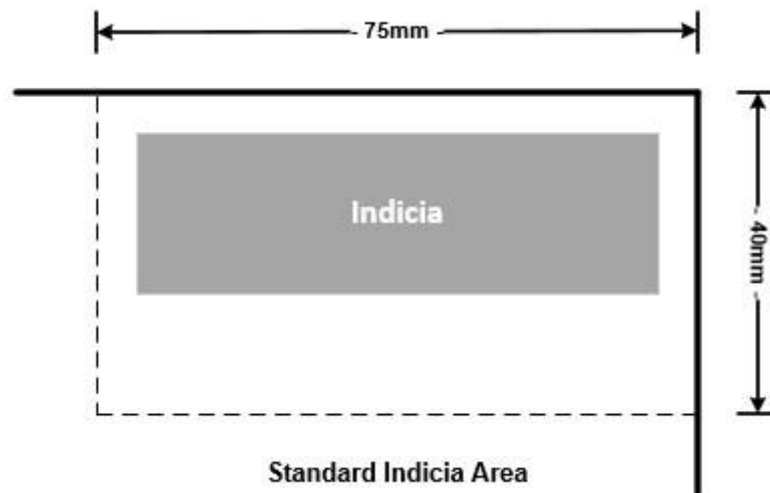

Figure 1 - Indicia Area (Not to Scale)

Printed Postage Impression including barcode Indicia Design

The design consists of the Royal Mail Branding Mark which is surrounded by a border and positioned to the right of text and a 4-State Barcode. English and Bi-Lingual Welsh / English design variants are provided as illustrated in Figure 2 - Figure 3. The dimensions for the designs are provided below, and the details of the content are provided together with illustrations in subsequent sections.

| | English PPI with 4-State Barcode | Bi-Lingual Welsh / English PPI with 4-State Barcode |
|-----------------------------|----------------------------------|---|
| Overall Dimensions | 63mm long x 18mm high | 61mm long x 21mm high |
| Text & Code Area Dimensions | 39mm long x 18mm high | 39mm long x 21mm high |
| Branding Dimensions | 17mm long x 18mm high | 17mm long x 21mm high |

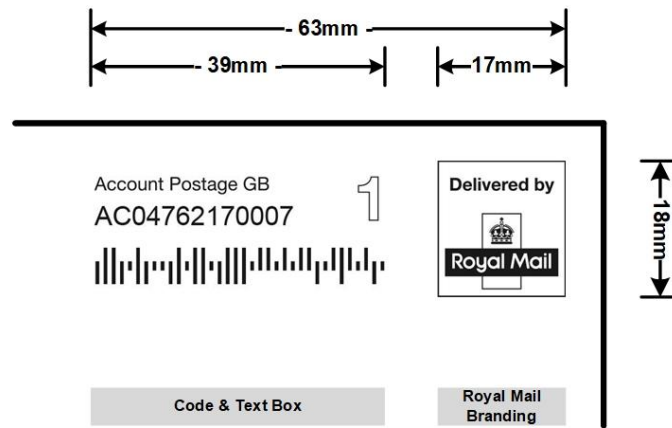

Figure 2 – 1st Class English (Not to scale)

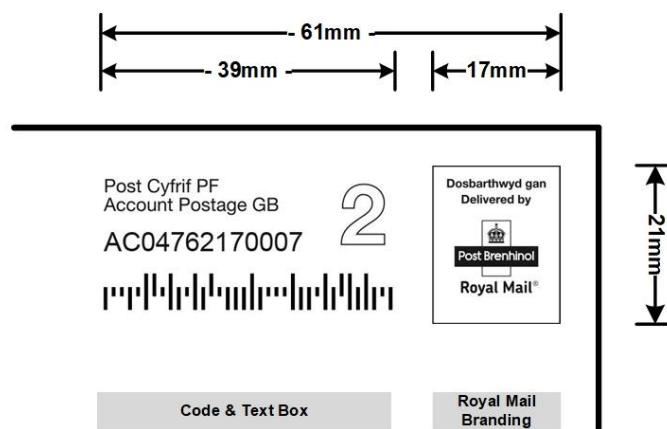

Figure 3 – 2nd Class Bi-lingual Welsh / English (Not to scale)

Content Definition

The Text & Code Area content is defined in the table below:-

| Component | Text & Code Area |
|------------------------|---|
| 'Account Postage' Text | <p>The Account Postage text is printed in the top left corner of the Text & Code Area as follows :-</p> <ul style="list-style-type: none"> • 'Account Postage GB' is printed on English designs. • 'Account Postage GB' and 'Post Cyfrif PF' on the Bi-Lingual Welsh / English designs; the 'Post Cyfrif PF' text being printed above the 'Account Postage GB' text. • It is printed in title case using 7pt Helvetica font. • It is printed 2mm from the left edge of the Text & Code Area. 'Account Postage GB' is printed 4mm from the top of the Text & Code Area in the English design, and 'Post Cyfrif PF' is printed 3.5mm from the top of the Text & Code Area in the Bi-Lingual Welsh / English design. |

| Component | Text & Code Area |
|--|---|
| Account Number Text | <p>The Account number is printed beneath the Account postage text as follows :-</p> <ul style="list-style-type: none"> It is prefixed by 'AC' and includes 8 numerals, 2 alpha numerics, and a single character checksum suffix ¹ as defined on page 16. Where the Account Number has less than 10 characters, preceding zeros must be added. It is printed using 10pt Lucida Console upper case font. A clear zone of 1.3mm is provided around the Account Number as illustrated in Figure 4. It is printed 2mm from the left edge of the Text & Code Area, and is printed 9mm from the top of the Text & Code Area in the English design, and 11mm from the top of the Text & Code Area in the Bi-Lingual Welsh / English design. |
| Service Indicator - English | <p>A numeric service indicator is required as follows :-</p> <ul style="list-style-type: none"> 1 or 2 only It is printed using a Helvetica outline font and is 6mm high. The font outline thickness is as follows :- <ul style="list-style-type: none"> 1st Class Design - 0.402pt 2nd Class Design - 0.41pt It is printed 1.5-2mm from the top of the Text & Code Area and is right justified. |
| Service Indicator - Welsh / English Bi-lingual | <p>A numeric service indicator is required as follows :-</p> <ul style="list-style-type: none"> 1 or 2 only It is printed using a Helvetica outline font and is 8mm high. The font outline thickness is as follows :- <ul style="list-style-type: none"> 1st Class Design - 0.45pt 2nd Class Design - 0.45pt It is printed 2.5mm from the top of the Text & Code Area and is 1mm right from the right of the Text & Code Area. |
| 4-State Barcode | <ul style="list-style-type: none"> The Mailmark Barcode D is positioned in the bottom left corner of the Text & Code Area as follows. The requirements for the barcode are provided in at a pitch of 24 bars per 25.4mm. The bars must be printed in a field that is 38.2mm long and 4.7mm high. A clear zone of at least 2mm is required on all four sides around the Barcode. The Barcode has 36 bars and is printed in a barcode field size of 42.1mm x 8.6mm.) It is printed 2mm from the left and bottom of the Text & Code Area. |

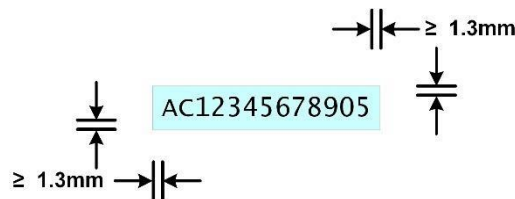

Figure 4 – Account Number Clear Zone (Not to scale)

¹ The suffix provides a checksum. It enables a level of error detection and correction to be performed on the account number.

² This equates to a minimum field size of 30.1mm x 5.8mm.

The Branding content is defined in the table below:-

| Design | Branding |
|----------------------------|--|
| English | <ul style="list-style-type: none"> • The English Branding consists of 'Delivered by' text printed above an English Royal Mail cruciform. • The border that surrounds Branding is 0.5pt wide. • The 'Delivered by' text is printed in title case using Helvetica 6.75pt bold font. It is printed 2mm below the top border and is centre justified. • The Royal Mail cruciform is 10mm high and is inset by 1mm from the left bottom, and right borders. |
| Welsh / English Bi-lingual | <ul style="list-style-type: none"> • The Bi-Lingual Welsh / English Branding consists of 'Dosbarthwyd gan' text followed by 'Delivered by' text on a second line above a Welsh Royal Mail cruciform. • The border that surrounds Branding Area is 0.5pt wide. • 'Dosbarthwyd gan' text is printed above 'Delivered by' text. Both are printed in title case using Helvetica 4.5pt bold font. 'Dosbarthwyd gan' is printed 1.5mm below the top border and is centre justified. • The Welsh Royal Mail cruciform and 'Royal Mail' text is 10mm high and is inset by 3mm from the left bottom, and right borders. |

Account Number Format

The Account Number is defined as follows:

AC<Digit><Digit><Digit><Digit><Digit><Digit><Digit><Digit><AlphaDigit><AlphaDigit><ChkSum>

e.g. AC12345678AZ8

The leading characters AC must be in upper case.

<Digit> contains characters in the range 0 to 9 inclusive

<AlphaDigit> contains characters in the range 0 to 9 inclusive and A to Z (upper case only inclusive)

<ChkSum> contains characters in the range 0 to 9 inclusive and is calculated as follows:

Modulo 10 sum of the elements

<Digit><Digit><Digit><Digit><Digit><Digit><Digit><Digit><AlphaDigit><AlphaDigit> from the account number defined above. i.e. all elements except the AC and <ChkSum>.

<Digit> shall have the values defined by the characters

<AlphaDigit> for the numeric characters shall have the values defined by the characters and for the Alpha characters shall have values assigned as follows:

| Character | Value |
|-----------|-------|
| A | 10 |
| B | 11 |
| : | : |
| Z | 35 |

Example checksum calculation

For example, an account number without a checksum of: AC12345678AZ, would have the following value:









$$1 + 2 + 3 + 4 + 5 + 6 + 7 + 8 + 10 + 35 = 81$$

This would generate a checksum of: 1 (as the final number in the sum is assigned as the checksum.)

Giving a final printed account number of: AC12345678AZ1



Indicia Illustrations

| | |
|---|--|
| <p>Account Postage GB AC04762170007</p>  <p>1</p>  | <p>Account Postage GB AC04762170007</p>  <p>2</p>  |
| <p>Figure 5 - 1st Class English (Not to scale)</p> | <p>Figure 6 - 2nd Class English (Not to scale)</p> |
| <p>Post Cyfrif PF Account Postage GB AC04762170007</p>  <p>1</p>  | <p>Post Cyfrif PF Account Postage GB AC04762170007</p>  <p>2</p>  |
| <p>Figure 7 - 1st Class Bi-Lingual Welsh / English (Not to scale)</p> | <p>Figure 8 - 2nd Class Bi-Lingual Welsh / English (Not to scale)</p> |

4-State Barcode Requirements

The 4-State barcode is a Mailmark 4-State Barcode D that uses the bar symbology and dimensional standards of a Customer Barcode (also known as a CBC and Barcode) with a defined data content applicable to its type. The data is encoded to produce a barcode that includes bars in 4 possible states - “D” = Descender bar, “A” = Ascender bar, “F” = Full bar, “T” = Track bar (DAFT).

The codes must be printed in black on a lighter (contrasting) background. Details of the code content is provided in the EIB Barcode Specification, and printing requirements for the code are provided below.

| Design Ref. | Code Content | | | | |
|-------------------------------|------------------|----------------|---------------|--------------|--------------------|
| | Info Type (1) | Version (1) | Format (1) | Class (1) | Licence No. (6) |
| English 1 st Class | 3 | 1 | 0 | 1 | UBRALU |
| English 2 nd Class | 3 | 1 | 0 | 2 | UBRALU |
| Welsh 1 st Class | 3 | 1 | 0 | 1 | UBRALX |
| Welsh 2 nd Class | 3 | 1 | 0 | 2 | UBRALX |

Printing Requirements

The printing requirements are aligned to the requirements for Mailmark 4-State Codes. The key requirements are provided in the following extract.

| Printing Reqts. | |
|----------------------------|--|
| Location | <ul style="list-style-type: none"> The Indicia must be wholly positioned in the top right corner of the mail piece and be 5mm +/- 2mm from the top edge and 5mm +/- 2mm from the right edge as illustrated in Figure 9. |
| Indicia & Substrate Colour | <ul style="list-style-type: none"> The Indicia must be printed in black on a lighter (contrasting) background subject to the contrast ratio requirements below. The design must not be printed as a negative. The print quality shall be consistent throughout the indicia. The edges of the barcode must be sharp and clearly defined. No other text, patterning, or graphics shall be printed in the indicia area and its clear zone. |
| Print Quality | <ul style="list-style-type: none"> The Indicia must be printed at a minimum resolution of 300dpi Indicia including 4-State barcodes must achieve a minimum Print Contrast Ratio of 40%, and a minimum Reflective Difference of 30%. |
| Skew | <ul style="list-style-type: none"> The maximum skew for the whole Indicia is +/- 5° from the horizontal axis. |

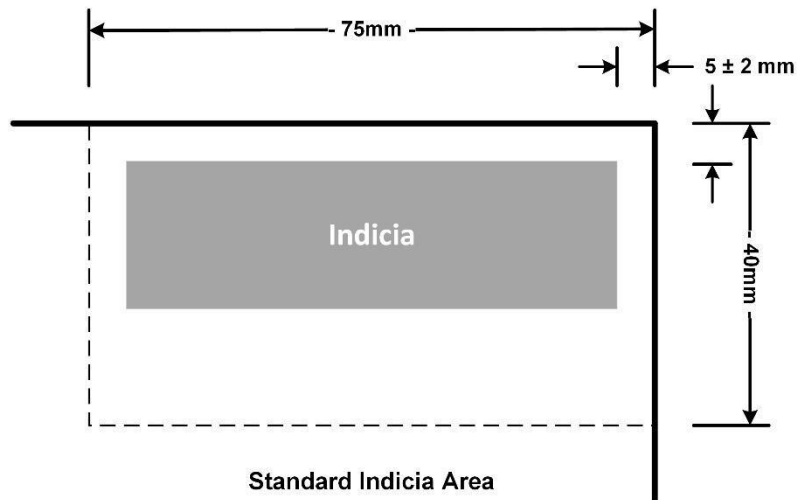

Figure 9 - Indicia Print Area (Not to Scale)

Appendix 1a - Printed Postage Impression with separate barcode specification

Introduction

This design alternative is intended for use when corporate branding or departmental billing requirements make the use of the Printed Postage Impression including barcode impractical. It utilises a standard printed postage impression together with a separate Unsorted 4-state barcode.

Purpose

The section specifies requirements for the printed postage impression with separate barcode indicia designs. The design elements are as follows :-

- A Standard Royal Mail Printed Postage Impression. Go to www.royalmail.com/ppi for full details.
- The barcode content from a Printed Postage Impression including barcode that is aligned to the standard PPI in terms of the class and account

Scope

- 1st & 2nd Class designs are required together with Bi-Lingual Welsh / English variants.
- The designs will be printed onto the mail piece either by customers or by their suppliers.
- Scaling of the designs is not permitted.

Indicia Location

The Printed Postage Impression indicia designs (and their associated clear zones) must be wholly positioned in the top right corner of the mail piece in an area 75-103mm long and 40mm high.

A minimum clear zone of 2mm is required around the indicia design on all sides.

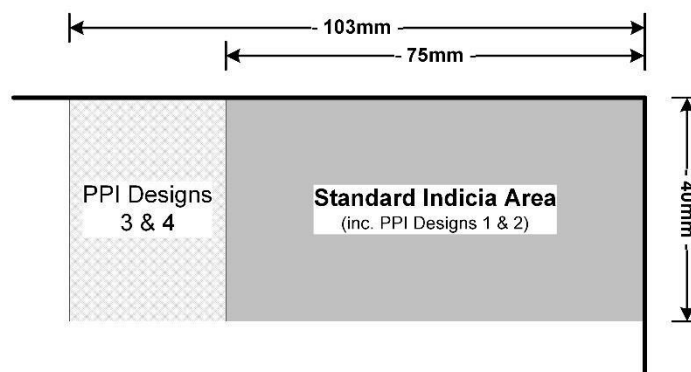

Figure 10 - Indicia Area (Not to Scale)



Barcode Design

The Printed Postage Impression including barcode must be created as defined in Appendix 1, ensuring that the mail class is aligned to the PPI indicia and that the appropriate PPI account information is used.

The barcode element of the design must then be extracted and located on the window insert adjacent to the address.

Barcode Printing Requirements

The printing requirements are aligned to the requirements for Mailmark 4-State Codes. The key requirements are provided in the following extract.

| | Printing Requirements |
|-----------------------|--|
| Location | <ul style="list-style-type: none">• The barcode must be wholly positioned within the window, and it is recommended that it is located above (or below) and parallel to the address, and left justified with the address.• A clear zone of 2mm must be maintained on all four sides of the 4-State barcode.• The clear zone requirements apply at all times, including when the envelopes are used and after the mail item is tapped on all four edges, to induce maximum insert movement (i.e. the whole of the 4-State barcode and the address block together with their required clear zones must be visible at all times). |
| Barcode Print Quality | <ul style="list-style-type: none">• The 4-State barcode must be printed in a contrast medium, typically black bars on a white background.• No other text, patterning, or graphics shall be printed or present in the barcode area and its clear zone (i.e. this may be design graphics or mailpiece substrate characteristics).• A minimum Print Contrast Ratio (PCR) and a minimum Reflective Difference (RD) must be applied. These values are minimum PCR is 40%, and Minimum RD is 30%.• The print quality shall be consistent throughout the bars.• The edges of the 4-State Mailmark barcode should be sharp and clearly defined.• Printing or embossing of security backgrounds, if essential, should be faint, of uniform consistency and be on the inside of the envelope. |
| Symmetry & Skew | <ul style="list-style-type: none">• The vertical alignment of the code must be consistent. The track element of the bars must be symmetrical about the centre line of the code, plus or minus 10% of the height of the centre line.• The barcode skew must be less than plus or minus 5°. |

Appendix 2 Clear addressing and mail piece guide

Addressing for Letters and Large Letters

- You must include one premise element, one thoroughfare element, one locality element and the postcode as a minimum.
- The post town should be included
- Other elements may be included.
- If there is no thoroughfare element contained in PAF® this need not be included.

| | |
|---------------------------|---|
| (optional) | Mailer Defined Information (MDI)* e.g. ZW4367 |
| | D Faydherbe Operations Director |
| Organisation | Royal Mail |
| Sub-building | South Wing |
| Building name | Bell House |
| Building number | B 25 Bell Complex |
| Dependent thoroughfare | The Mews |
| Thoroughfare | 300 Western Road |
| Double dependent locality | Otterley |
| Dependent locality | Hedge End |
| Post Town | OXFORD |
| Postcode | OX4 5ZZ |

*see Address structure and layout for details on Mailer Defined Information

- Each address element must be on a separate line of the address with the postcode included as the last line of the address. The only exception to this is outlined in the Locality elements section.
- The county, although not required, may be included as the penultimate line of the address
- The phrases “England”, “Great Britain” or “United Kingdom” must not be used for addresses to the UK and posted within the UK.
- Each line of the address must be left justified

The simplest way to ensure an address is correct is to check that all the elements in the appropriate PAF® record are present.

To fully describe these requirements, each element is defined as follows,



Premise elements

You must include at least one of these four elements, so that a single delivery point is defined. You don't have to include all the premise elements, even if they are included in PAF®.

| | |
|-----------------|--|
| (optional) | Mailer Defined Information e.g. ZW4367 |
| | D Faydherbe Operations Director |
| Organisation | Royal Mail |
| Sub-building | South Wing |
| Building name | Bell House |
| Building number | B 25 Bell Complex |

Thoroughfare elements

PAF® will give one of three possible combinations:

- No thoroughfare: no need to include anything in this part of the address.
- A thoroughfare but not a dependent thoroughfare: include the thoroughfare.
- Both a dependent thoroughfare and a thoroughfare: include the former. If space allows you can also include the thoroughfare, though it's not compulsory.

| | |
|------------------------|------------------|
| Dependent thoroughfare | The Mews |
| Thoroughfare | 300 Western Road |

Locality elements

You must include at least one locality element. You don't have to include them all, even if they are included in PAF®. The Post Town should have the first character(s) in capitals for example: Coventry, Milton Keynes, Ross-On-Wye, on a single line.

The Post Town maybe followed by a county on the penultimate line of the address, provided that the space between Post Town and county is no more than two character spaces and that the postcode is on the last line of the address.

The county and the postcode may be on the same line provided there are one or two character spaces between the two elements.

The Post Town and postcode can be on the same line, provided that the Post Town precedes the postcode and the space between the two elements is one or two character spaces.



| | |
|---------------------------|-----------|
| Double dependent locality | Otterley |
| Dependent locality | Hedge End |

Postcode

The address must contain the full and accurate postcode. The postcode must be able to generate an address from PAF® which can be matched to the minimum requirements above (at least one premise element, one thoroughfare element and one locality element).

The postcode must always appear in capital letters on the last line of the address.

Please put one or two character spaces between the two parts of the postcode. Typically, the first part (i.e. OX4) is the outward code and this identifies a post town or a district within a post town, the second (i.e. 5ZZ) is the inward code which represents the street information.

| | |
|-----------|---------|
| Post Town | OXFORD |
| Postcode | OX4 5ZZ |

Punctuation

- Please do not underline any part of the address or postcode.
- Punctuation and non-alpha numeric symbols can only be used where it appears in the corresponding PAF™ record. It can also be used in the recipient's name or in the Mailer Defined Information (MDI) above the address within the address block. There must be no punctuation used to separate address elements or components within an address element.
- Alternatively, you may remove all punctuation from the address, even if it is contained in the corresponding PAF™ record.
- For full details on allowable punctuation within a PAF record please see PAF™ Digest, available from www.royalmail.com or a member of your account team.
- Punctuation and graphical symbols may be used within any 'Mailer Defined Information' and addressee elements.

British Forces Post Office (BFPO) Addresses

A full list of BFPO addresses is available here [HM Forces Mail](#).

Address layout is as follows & please note that the Town & Country must not be included:

Service No Rank Name
Unit/Regt
Operation Name
BPFO No

Please go to www.royalmail.com and HM Forces Mail for full details, and any restrictions - [Royal Mail HM Forces Mail](#).

ADDRESS STRUCTURE AND LAYOUT

An address may consist of three elements, all of which are classed as the 'Address Block'.

1. Mailer Defined information (MDI) – reference information printed as part of the Address Block
2. Recipient details
3. Geographical address and postcode



Address requirements

| Requirements | |
|---|--|
| No of addresses | There must only be one Delivery Address Block on the mail piece |
| Mailer Defined Information format (MDI) | <ul style="list-style-type: none">• Must be in a single line above the address• The first character of the MDI must be left justified and aligned to the address below it• Any separation between elements of the MDI should not exceed one space• The content may be of different font and size to the other Address Block elements• The font and size may vary within the Mailer Defined Information (MDI)• The line spacing must be consistent with the Delivery Address |

| Requirements | | | | | | | | | | | | | | | | | | | | | | | | | |
|-------------------------------|--|-------|-------------|-------------|--------|---------|----------------|-------------------|--------|-----------|-------|------------------|--------|------------------------|--------------|---------|-------|--------|---------|-----------|---------|-----------|--|-------|--|
| | <ul style="list-style-type: none"> The length of the MDI must not exceed 64 characters When included as part of the address block, it may tap out totally or partially above and to the right | | | | | | | | | | | | | | | | | | | | | | | | |
| Punctuation & graphic symbols | <ul style="list-style-type: none"> Please refer to 'Punctuation' under 'Addressing' | | | | | | | | | | | | | | | | | | | | | | | | |
| Fonts | <ul style="list-style-type: none"> The font size for the Delivery Address must be the same or larger than the Return Address Block Italic fonts must not be used Bold fonts must not be used Recommended fonts as follows and are point size 10-12. Non-Proportionally Spaced preferred fonts (7) Courier Courier New Letter Gothic Lucida Console Lucida Sans Typewriter OCR B Word Gothic <p>Acceptable Proportionally Spaced fonts (22)</p> <table> <tbody> <tr> <td>Arial</td> <td>Lucida Sans</td> </tr> <tr> <td>Avant Garde</td> <td>Mangal</td> </tr> <tr> <td>Calibri</td> <td>News Gothic MT</td> </tr> <tr> <td>Estrangelo Edessa</td> <td>Optima</td> </tr> <tr> <td>Eurostile</td> <td>Raavi</td> </tr> <tr> <td>Frankfurt Gothic</td> <td>Shruti</td> </tr> <tr> <td>Franklin Gothic (Book)</td> <td>Trebuchet MS</td> </tr> <tr> <td>Gautami</td> <td>Tunga</td> </tr> <tr> <td>Geneva</td> <td>Univers</td> </tr> <tr> <td>Gill Sans</td> <td>Verdana</td> </tr> <tr> <td>Helvetica</td> <td></td> </tr> <tr> <td>Latha</td> <td></td> </tr> </tbody> </table> <p>* Note that all the fonts above are in the correct type</p> | Arial | Lucida Sans | Avant Garde | Mangal | Calibri | News Gothic MT | Estrangelo Edessa | Optima | Eurostile | Raavi | Frankfurt Gothic | Shruti | Franklin Gothic (Book) | Trebuchet MS | Gautami | Tunga | Geneva | Univers | Gill Sans | Verdana | Helvetica | | Latha | |
| Arial | Lucida Sans | | | | | | | | | | | | | | | | | | | | | | | | |
| Avant Garde | Mangal | | | | | | | | | | | | | | | | | | | | | | | | |
| Calibri | News Gothic MT | | | | | | | | | | | | | | | | | | | | | | | | |
| Estrangelo Edessa | Optima | | | | | | | | | | | | | | | | | | | | | | | | |
| Eurostile | Raavi | | | | | | | | | | | | | | | | | | | | | | | | |
| Frankfurt Gothic | Shruti | | | | | | | | | | | | | | | | | | | | | | | | |
| Franklin Gothic (Book) | Trebuchet MS | | | | | | | | | | | | | | | | | | | | | | | | |
| Gautami | Tunga | | | | | | | | | | | | | | | | | | | | | | | | |
| Geneva | Univers | | | | | | | | | | | | | | | | | | | | | | | | |
| Gill Sans | Verdana | | | | | | | | | | | | | | | | | | | | | | | | |
| Helvetica | | | | | | | | | | | | | | | | | | | | | | | | | |
| Latha | | | | | | | | | | | | | | | | | | | | | | | | | |
| Address Block Text formatting | <ul style="list-style-type: none"> The address must be provided as a 'block' of text. The content of one address line must not be wrapped on to a second line of text i.e. London Road must be printed on the same line and not be spread over 2 lines. Characters of the same font and point size must be used for each line of the address Character pitch must be 10-12 characters per 25.4mm with clear vertical gaps of at least 0.25mm between the extremities of adjacent characters. Spacing between words must be < 5mm | | | | | | | | | | | | | | | | | | | | | | | | |

| | Requirements |
|--|--|
| | <ul style="list-style-type: none"> • Maximum characters per line of the Address Block is 64 characters (including spaces) • Spacing between lines must be uniform: Minimum – 1mm, Maximum – 4mm • There must be no “blank” lines in the address • All elements of the Address Block (including the Mailer Defined Information) must be left justified • The Address Block skew must be no more than plus or minus 5 degrees |

Address print requirements

| | Requirements |
|------------------------|---|
| Print colour & quality | <ul style="list-style-type: none"> • Preferred colour is black. If this cannot be achieved, then adequate contrast must be achieved • Negative contrast is not allowed • The characters must not be blurred, smudged, deformed or incomplete • No splashing or ink splatter around characters |
| Print contrast | <ul style="list-style-type: none"> • Required Print Contrast Ratio for addresses printed on envelopes $\geq 50\%$ • Required Print Contrast Ratio for addresses printed on window inserts $\geq 55\%$ • Required Value: Minimum Reflective Difference $\geq 30\%$ • Required Value: Minimum Background Reflectance $\geq 35\%$ • Inverse printing is not allowed (address block lighter than background) |

Address print advice for labels

If you wish to print all your address and indicia information on a label we would recommend that, as per the advice in this guide, you follow the general principle of ensuring that

- a) the indicia is to the top right of the label and item
- b) the delivery address is below and to the left of the indicia
- c) the delivery address and indicia are both orientated in the same direction
- d) the return address to be above and to the left of the delivery address
- e) all other requirements e.g. clear zones, layout, address structure remain as per this guide

Return Addresses – Letters

We recommend that in each instance you apply a valid UK return address to all your mail as this not only allows us to return items which cannot be delivered but helps you maintain accurate address files. The preferred requirements are that the Return Address is on the back of the item and in an area no more than 40mm from the top, it is positioned central and left justified

The content of any return address must follow the structure as shown for the delivery address but most importantly it must have the words 'Return Address' as the standard prefix on the top line of the block of text.

When on the front, it must be in the top left corner, at least 75mm from the right edge and cannot extend to lower than 40mm from the top edge of the letter and cannot be closer than 12mm to the Delivery Address Block

Return Addresses – Large Letters

There must be only one Return Address Block on the large letter and if the size of the finished mail piece is C5 (162mm x 229mm) then it must be placed on the back of the mail piece. This is because we need to ensure that we reduce any Instances where the incorrect address will be read, possibly resulting in poor quality of service.

When on the back, it must be within an area within 40mm zone from the top of the mail piece.

For items larger than C5 (>162mm in length and > 229mm in height) we recommend the return address to be on the back. This is not mandatory

- When on the front, it must be in the top left corner, and cannot extend to lower than 40mm from the top edge of the letter and cannot be closer than 12mm to the Delivery Address Block.

Letters detail

| | Requirements |
|------------------------------------|---|
| Material | <ul style="list-style-type: none"> Paper only |
| Paper weight (minimum) | <ul style="list-style-type: none"> Envelope paper: 70gsm Single piece mailer: 100gsm Postcards: 200gsm |
| Shape | <ul style="list-style-type: none"> Four sides that are straight lines all intersected by a 90° angle i.e. Rectangular, square shapes |
| Orientation | <ul style="list-style-type: none"> Landscape is preferred |
| Paper Opacity | <ul style="list-style-type: none"> ≥ 85 % (BS ISO 2471 - Paper and board. Determination of opacity (paper backing)) |
| Paper Absorbency | <ul style="list-style-type: none"> 15 – 35 gsm of water in 1 minute (BS EN 20535 - Paper and board. Determination of water absorptiveness.) |
| Paper Porosity | <ul style="list-style-type: none"> < 700 ml/minute (BS 6538-2 - Air permeance of paper and board.) |
| Paper Colour | <ul style="list-style-type: none"> White, pale and buff coloured envelopes work best through our machines. If your envelope has designs printed on it we ask that you maintain two 'clear zones' free of colour, print, graphics or window material. These clear zones are :- <ul style="list-style-type: none"> The Tag Codemark clear zone that is located 60mm up from the bottom right corner of the Letter, and covers an area 10mm high, and 100mm long (from the right edge of the Letter). The Route Codemark clear zone that is in the bottom right corner of the Letter and covers an area 18mm high (from the bottom edge of the mailpiece), and 130mm long (from the right edge of the Letter). |
| Thickness | <ul style="list-style-type: none"> Minimum: 0.25mm Maximum: 5mm |
| Lateral movement of largest insert | <ul style="list-style-type: none"> If the total item (envelope + contents) thickness is up to or equal to 2mm it can be less than or equal to 30mm If the total item (envelope + contents) thickness is up to or equal to 5mm this must be less than or equal to 20mm |
| Inserts | <ul style="list-style-type: none"> Large metal objects not permitted e.g. keys, coins Staples maximum size permitted is 24mm by 6mm Paper clips maximum size permitted is 23mm long |
| Rigidity / Stiffness | <ul style="list-style-type: none"> Items must be able to bend into a 'U' shape. |

| | Requirements |
|-----------------------|--|
| Envelope construction | <ul style="list-style-type: none"> • The front of envelope is defined as the side bearing the delivery address and payment indicia • Envelope to be paper-based • Securely sealed on the front, back and all edges • Opening flap may be on the front or the back of the mail item. If the flap folds to the front it must not <ul style="list-style-type: none"> a) fall within the 'clear zones' here in the Machine Readable Letters & Large Letters document, section, 'Clear zones for letter format mail pieces' or, b) have a Barcode printed over it • Envelopes with apertures must have a window film covering the aperture • All window film must be securely and evenly sealed to the inside of the envelope and must be flat when fixed to the envelope • Adhesives used must not leak onto the open envelope surface and must be dry on presentation so that items are not stuck together |
| Sealing | <ul style="list-style-type: none"> • Opening flaps to be sealed to within 25mm of the envelope sides and within 35mm from the top of the envelope – as shown below. This applies to all envelope types. <div data-bbox="726 1086 1236 1411" style="text-align: center;"> <p>The diagram illustrates the sealing requirements for an envelope flap. It shows a top-down view of the flap, which is shaded grey. The flap is labeled 'Envelope Flap'. The diagram includes the following dimensions and labels:</p> <ul style="list-style-type: none"> Top edge: 35mm Unsealed. Label: 'The edge of the flap MUST be sealed within this area'. Bottom edge: 35mm Unsealed. Label: 'The edge of the flap MUST be securely sealed within this area'. Left side: 25mm Unsealed. Label: 'The edge of the flap MUST be sealed within this area'. Right side: 25mm Unsealed. Label: 'The edge of the flap MUST be sealed within this area'. </div> |
| Perforations | <ul style="list-style-type: none"> • Roulette perforations are permitted. |
| Zip Ties | <ul style="list-style-type: none"> • Zip Tie perforations are permitted. |

Large Letters detail

| | Requirements |
|------------------------------------|---|
| Material | <ul style="list-style-type: none"> Paper or polymer envelope / poly wrap (poly details are in appendix 3) |
| Paper weight (minimum) | <ul style="list-style-type: none"> Envelope paper: 70gsm |
| Shape | <ul style="list-style-type: none"> Four sides that are straight lines all intersected by a 90° angle i.e. Rectangular, square shapes |
| Orientation | <ul style="list-style-type: none"> Landscape is preferred |
| Paper Opacity | <ul style="list-style-type: none"> ≥ 85 % (BS ISO 2471 - Paper and board. Determination of opacity (paper backing) |
| Paper Absorbency | <ul style="list-style-type: none"> 15 – 35 gsm of water in 1 minute (BS EN 20535 - Paper and board. Determination of water absorptiveness.) |
| Paper Porosity | <ul style="list-style-type: none"> < 700 ml/minute (BS 6538-2 - Air permeance of paper and board.) |
| Paper Colour | <ul style="list-style-type: none"> White, pale and buff coloured envelopes work best through our machines. More information on clear zone design requirements can be found here in the Machine Readable Letters & Large Letters document, section, 'Clear zones for letter format mail pieces' |
| Thickness | <ul style="list-style-type: none"> Minimum: 0.5mm Maximum: 25mm |
| Lateral movement of largest insert | <ul style="list-style-type: none"> If the total item (envelope + contents) thickness is up to or equal to 2mm it can be less than or equal to 30mm If the total item (envelope + contents) thickness is up to or equal to 10mm this must be less than or equal to 20mm |
| Inserts | <ul style="list-style-type: none"> Large metal objects not permitted e.g. keys, coins Staples maximum size permitted is 24mm by 6mm Paper clips maximum size permitted is 23mm long |

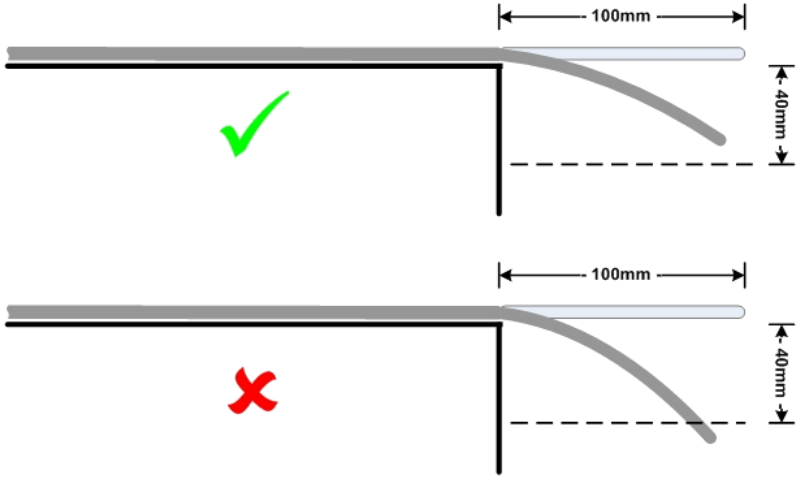
| Requirements | |
|-----------------------|--|
| Rigidity / Stiffness | <p>The Acceptable Rigidity / Stiffness for a Large Letter is greater than or equal to 8N.mm. This is determined using the test below:-</p> <ul style="list-style-type: none"> • A single Large Letter is placed on a flat surface with the shortest edge of the Large Letter overhanging a straight edge of a flat surface by a horizontal distance of 100mm. • The leading edge of the Large Letter is then released and allowed to bend down under its own weight. • If the leading edge drops to 40mm or more, then the stiffness is less than 8N.mm then the Large Letter will not be machineable.  |
| Envelope construction | <ul style="list-style-type: none"> • The front of envelope is defined as the side bearing the delivery address and payment indicia • Envelope to be paper-based • Securely sealed on the front, back and all edges • Opening flap may be on the front or the back of the mail item. If the flap folds to the front it must not; <ul style="list-style-type: none"> a) fall within the 'delivery address block b) have a Barcode printed over it • Envelopes with apertures must have a window film covering the aperture • All window film must be securely and evenly sealed to the inside of the envelope and must be flat when fixed to the envelope • Adhesives used must not leak onto the open envelope surface and must be dry on presentation so that items are not stuck together |

Requirements

Sealing

- Opening flaps to be sealed to within 25mm of the envelope sides and within 35mm from the top of the envelope – as shown below. This applies to all envelope types.

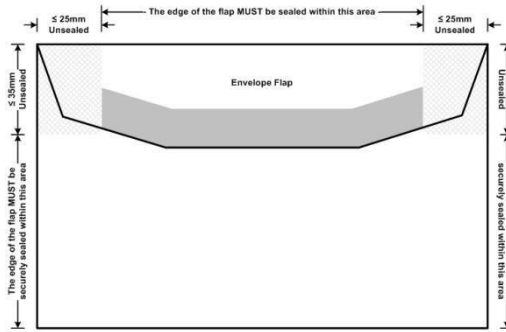

Appendix 3 Technical recommendations for polymer envelopes and poly wrapped large letter items

For ease of use, this element of the user guide has been separated into general recommendations and requirements which cover polymer envelopes and poly wrapped mail pieces, then requirements specific to both outer covering options are listed.

Design of Logos or Advertising

To reduce any potential for address interpretation errors, we do not recommend that logos and/or advertising look like an address, geographical location, country or a Royal Mail bag or bundle label, and they must not be printed in the Delivery Address Block, over the barcode, in any clear zones around either the Delivery Address Block and/or the barcode, or in the indicia area. Slogans where the company name contains the words 'Return', 'Address' and 'Undelivered' are not recommended.

Inserts

It is recommended that:

- for any insert other than the paper contents, they are fixed in position, so they don't move around during processing. You can use glue or self-adhesive tabs to fix any inserts
- inserts other than paper that are placed in an envelope are recommended to be fixed in position and attached to the insert, so that they cannot move around during the processing of the mail item. The inserts may include small metal objects such as keys, coins, and badges
- where you have 'step changes' in the thickness of the mail piece, the spatial distortion (i.e. variation in the thickness of the contents - see Figure 11), should not be more than 50% of the
- thickness of the item up to a maximum of 10mm and the address should be on the flat side of
- any item. It cannot be placed on any irregular or convex shaped sides

Figure 11

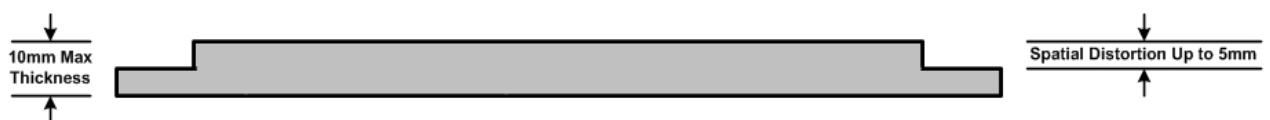

Polymer envelopes

For polymer envelopes or poly wrapped items, where the polymer is transparent only the largest insert must be visible to the front of the large letter, and we recommend that the lateral movement is less than 30mm (see Figure 1). There is no requirement for the content to be referenced to the bottom left corner. We recommend that there is no more than 30mm along the long edges and no more than 30mm along the short edges.

Please note:

For polymer envelopes or poly wrapped items you will need to allow for any lateral movement when defining the Delivery Address Block location. The assumption must be made that the poly may fold during processing and, should this happen; we still need a defined clear area from the edge to ensure the Delivery Address Block can be read.

Figure 12

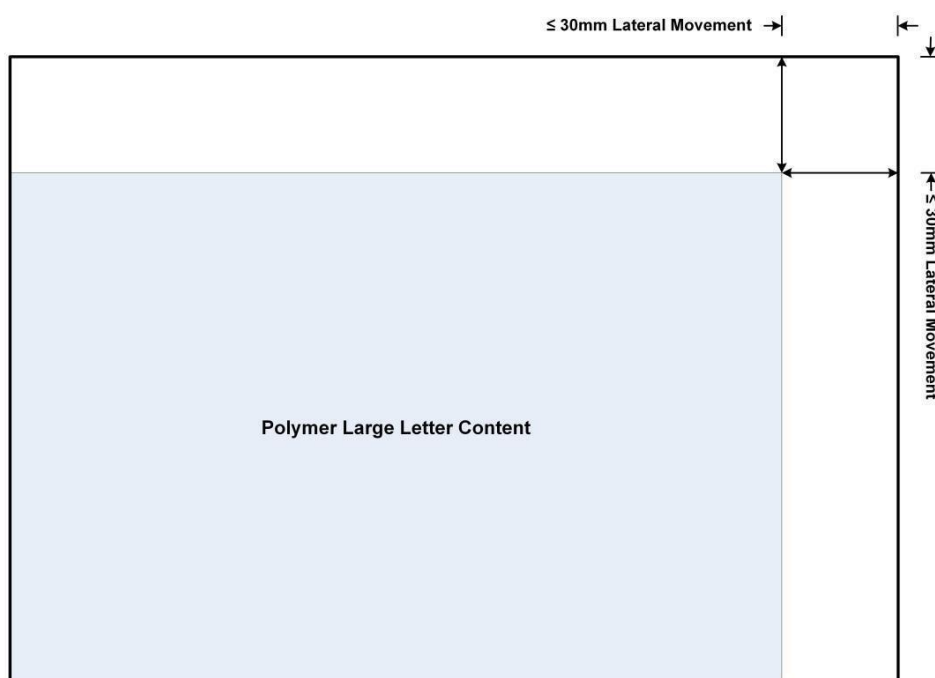

Material - Construction

Polymer envelopes and poly wrap

Polymer envelopes and poly wrap must be made of polymer film e.g. polyethylene

Material - general recommendation and requirements

- Glue: any adhesives used in the production of envelopes are recommended not to leak onto the open surface of the envelope and produce protruding mounds and is recommended to be fully cured when the mail is presented to Royal Mail. It is a requirement that mail pieces are not stuck together as we may not be able to read items that are, and your reports will appear incomplete. When polymer envelopes are used, it is recommended that the glue is stronger than the polymer and does not produce protruding moulds on the mail item
- Opacity: $\geq 85\%$ (BS ISO 2471 - paper and board (determination of opacity (paper backing)))

- Porosity: < 700 ml/minute (BS 6538-2 - air permeance of paper and board)
- Rigidity / Stiffness: it is recommended that the acceptable rigidity / stiffness is $\geq 8\text{N}\cdot\text{mm}$. There is no upper limit on mail piece stiffness

Rigidity and stiffness can be measured as follows (see also Figure 12):

- a single large letter should be placed on a flat surface with the shortest edge of the large letter overhanging a straight edge of a flat surface by a horizontal distance of 100mm
- the leading edge of the large letter is then released and allowed to bend down under its own weight
- if the leading edge drops to 40mm or more, then the stiffness is less than $8\text{N}\cdot\text{mm}$ and the large letter on machine-readable

Figure 12

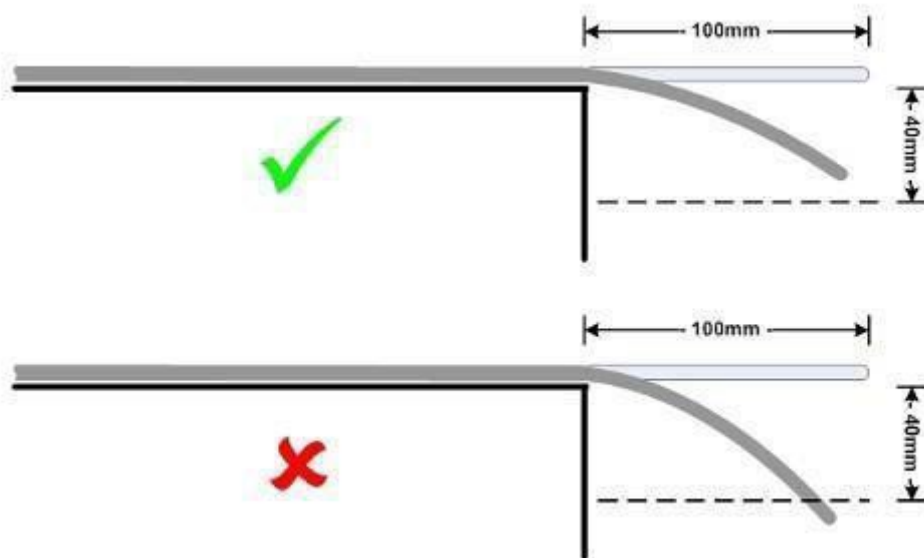

- Separation: the items must not be stuck together, and it is recommended that they are capable of separating to allow them to be effectively processed. When placed on a slope of 65° to the horizontal, it is recommended that the items are capable of separating, by sliding one from another, under the force of gravity (see Figure 13)

Figure 13

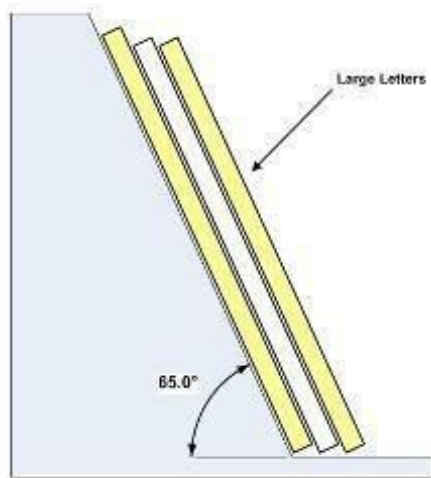

- Shape: items are required to be rectangular or square within the permitted dimensions and can be laid out (address and payment indicia) in landscape or portrait format. We do require you to ensure that the four sides are all straight lines and intersected by a 90° angle

Poly wrap outer

- the film is required to be intact, undamaged and must not be punctured or torn apart from perforations (although perforations are not recommended)
- it is recommended that the film is sufficiently strong enough to tolerate handling without tearing or splitting at the seals
- the film must be > 15 µm (15 microns) thick when measured at any point on the large letter other than the seal
- it is recommended that any text printed on the film adheres to the film and must not break up or wear during processing
- any barcode printed on the film must adhere to the film and must not break up or wear during processing
- only a single layer of film must cover the Delivery Address Block and barcode

Print contrast recommendations

- the Print Contrast Ratio for addresses printed on envelopes must be $\geq 50\%$
- the Print Contrast Ratio for addresses printed on window inserts must be $\geq 55\%$
- the Minimum Reflective Difference must be $\geq 30\%$
- the Minimum Background Reflectance must be $\geq 35\%$
- inverse printing i.e. negative contrast is not permitted (i.e. address block lighter than background)

Sealing

This section is divided into the paper and polymer envelope /poly wrap recommendations and requirements as they are different.

Polymer envelopes

It is recommended that:

- polymer envelopes are sealed along all the edges and have the opening flap on the back (see Figure 14)
- the opening flap is sealed to within a minimum of 25mm from the fold of the envelope flap and
- 25mm from the sides of the envelope (see Figure 14)

Figure 14

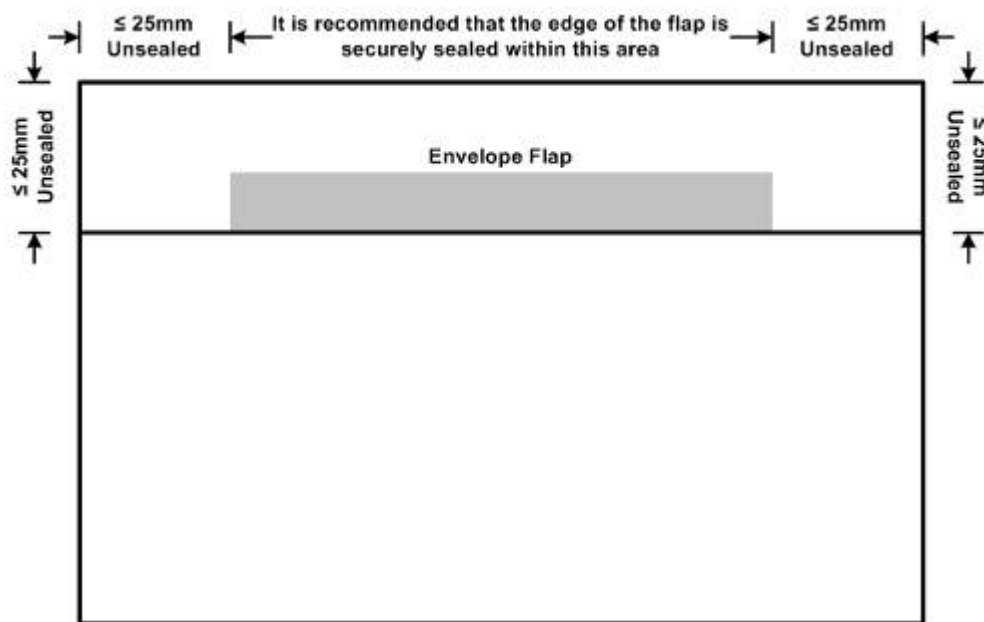

Poly wrapped items

Items which are poly wrapped must be securely sealed on the front, back and side edges. The recommendations for any seal which runs along the length, or width, of the item are as follows:

- the seal should be sealed at each end along the full length of the seal
- the free edge of the seal should be less than 30mm deep
- the preferred location for the seal is the back of the large letter
- due to the recommendations for the seal when placed on the front, it cannot be across the width of the mail piece (but if on the reverse it can)

If you have chosen not to have the seal on the reverse and have placed it on the front then please ensure you also meet the following requirements:

- the seal must not be over the Delivery Address Block or over the barcode
- the seal must be towards the bottom of the large letter and be no more than 90mm from the bottom edge (see Figure 15)

Figure 15

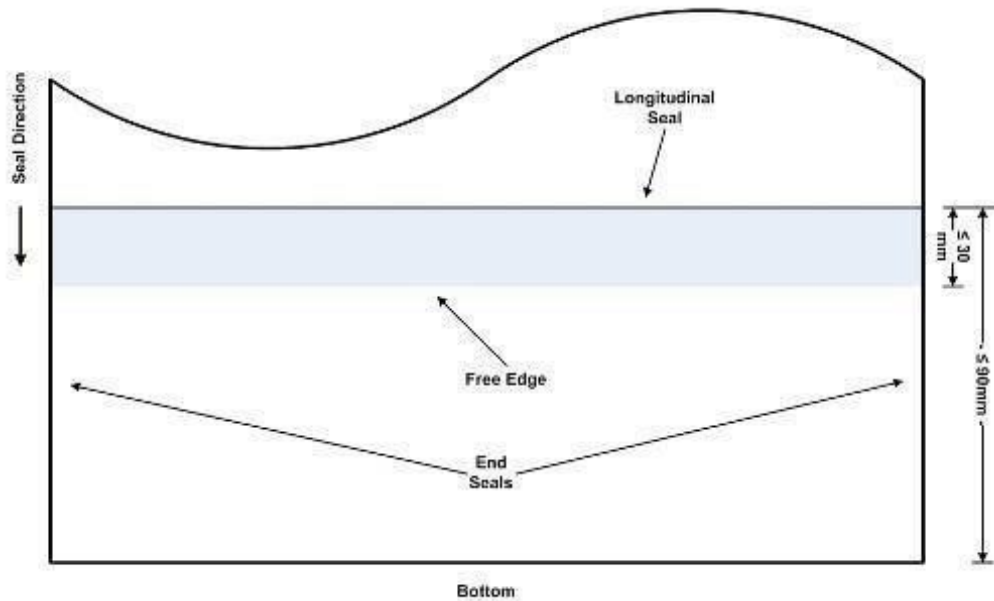

Delivery Address Block

- when printing the Delivery Address Block it is recommended that the maximum characters per line of the address block is sixty four. Please ensure that the content of one address line is not wrapped onto a second line i.e. Team Valley Trading Estate must be printed on the same line and not spread over two
- it is recommended that you use one of the fonts and sizes (detailed earlier in this section of the user guide) and ensure that each line of the address has characters which are the same font and point size and that the spacing between the words is less than 5mm.

The Delivery Address Block should not and the separate barcode must not be located in the following areas:

Polymer envelopes or poly wrapped items:

- the indicia area (40mm from the top of the envelope x 75mm from the right)
- the return address area (40mm down from the top and at least 75mm from the right)
- a 'frame' around the perimeter of the item (up to 45mm i.e. a mandatory 15mm and the remaining clear area is the excess poly of which 30mm is the maximum recommended. Therefore, if for example, your mail piece only had 10mm excess poly wrap then you would be expected to leave 25mm clear over the edge of the envelope flap)