

Royal Mail

User Guide for

Royal Mail Advertising Mail ®

April 2026



This is a legally binding document forming part of the Agreement between you and Royal Mail

Contents

Entry Criteria	4
Unsorted Options	7
Sorted Options	12
General Information	14
Audit Procedure	14

Dear Customer

Thank you for considering Royal Mail Advertising Mail. We have compiled this product guide to help you get started with using this product option.

We define Advertising Mail as 'mailings that comprise a largely uniform message to all addresses, with the purpose of promoting the sale or use of products or services, or to encourage contribution to, or support of a cause'

If you are not sure at this stage whether your mailing fits the definition you can contact us on 020 7371 6957, or by email at helpline@royalmailtechnical.com.

A copy of the DM Guidelines explaining which type of material qualifies as an Advertising Mail item can be found on the Royal Mail Technical Helpline (<https://www.royalmailtechnical.com>) or Royal Mail Website (<https://www.royalmail.com/business/marketing/advertising-mail>)

Please ensure that you have checked the contents of your item against the DM Guidelines to ensure that your item qualifies as Advertising Mail before posting.

Your Advertising Mail options at a glance:

Options	Choices
Delivery Speed	1st Class 2nd Class Economy + Economy deferred
Format	letter large letter
Machine-readability	not machine-readable Account or Machine-readable Advanced
Sorting	No Sortation Low Sort ⁱ
Containers	bags trays segregated bundles

To receive discounts for machine-readability you have the following options:

- Letters must meet our Royal Mail Mailmark® barcode, Machine-Readable Advanced specifications including minimum entry levels
- Large letters must meet our Mailmark®, Account or Machine-Readable Advanced specifications

Entry Criteria

To qualify for Advertising Mail, all mailings should:

- Contain 100% advertising items¹
- Must be letter or large letter format
- When sorted, be correctly presented as per the Low Sort options
- Meet the requirements of the data specification and provision of samples below
- Submit a seed or sample item to the Royal Mail Advertising Mail team for verification purposes

We reserve the right to check any part of an Advertising Mail posting and to undertake regular audits to ensure all items sent as Advertising Mail comply with the requirements of our Advertising Mail agreement with you.

Customer data - improving targeting

- Where data is not from a consent-based file², you must maintain a documented procedure for suppressing customer and prospect data against the Mail Preference Service (MPS), including MPS deceased. This must be in place and mailing files checked for recency thirty days or less before you post Advertising Mail items. For mail produced overseas where the transit time to the UK is greater than thirty days, mailing files should be checked for accuracy thirty days or less before the items are dispatched to Royal Mail and transit time to UK should be no longer than ninety days
- You must keep and maintain an internal suppression file³ to ensure that customers and prospects who request to opt out of your mailings are properly logged. This data must be checked thirty days or less before you post the item that uses the data. For mail produced overseas where the transit time to the UK is greater than thirty days, the data must be checked thirty days or less before the items are dispatched to Royal Mail and transit time to UK should be no longer than ninety days

¹ Defined as a posting comprising a largely uniform message to all addressees, with the purpose of promoting the sale or use of products or services, or to encourage contribution to, or support of, a cause.

A consent-based file is a data list where it can be proved that all customers and prospects have consented to receive direct marketing.

³ A suppression file is a list of names and associated personal details of individuals and organizations that have requested not to receive direct marketing communication.

Please note, RM Signed For cannot be added to this service.

Sample items

There are two options for you to fulfil the sampling process requirement.

Option 1.

- For each posting you must provide us with a sample of the item being posted at the same time as posting. You must provide a sample that is an exact reproduction of the items posted in terms of both envelopes used and contents enclosed for each Advertising Mail posting. It is not necessary to supply a sample from each cell of a mailing
- You must ensure the correct sales order line is highlighted for the associated mailing sample on the accompanying confirmed sales order, as we will check samples to ensure they conform to the Advertising Mail specification
- Both the sample item and copy of Sales order should be forwarded to Royal Mail at the address below

Option 2.

- It is possible to send in a seed sample at the time of mailing by using the following process;
- Add the address below in your mailing database
- Insert the account payers account number along with a job reference number into the top line used for mailer defined information (line one of the address block)

With either option the items will be sent to;

Advertising Mail Content Control Team 1M39
Royal Mail
Whitechapel Delivery Office
206 Whitechapel Road
LONDON
E1 1AA

Unsorted Options

Volume requirements

Volumes are per class, per day and per site

- letters – minimum 1,000 recorded on 1 sales order line
- large letters – minimum 250 recorded on 1 sales order line

Delivery speed choices

- 1st Class: we aim to deliver on the next working day after the day of posting**
- 2nd Class: we aim to deliver within three working days after the day of posting***

Format and weight

Product Option	Format	Weight
Not machine-readable	letter (up to 240mm x 165mm x 5mm) large letter (up to 353mm x 250mm x 25mm)	max 100g max 750g
Machine-readable	letter (up to 240mm x 165mm x 5mm) large letter (up to 345mm x 245mm x 13mm)	max 100g max 750g
Account or Machine-readable Advanced	letter (no smaller than 145mm x 110mm x 0.25mm), up to 240mm x 165mm x 5mm) large letter (up to 353mm x 250mm x 25mm)	max 100g max 750g

* To achieve discounts large letters should be 345mm x 245mm x 13mm.
Free collections apply to Advanced postings meeting the entry level criteria

** Exclusions: Postcodes: PH19 – 50, ZE1, ZE2 & ZE3, HS1-5, HS6, HS7-8 & HS9, KW16, KW15, KW17, JE1 – JE4 and IM1 – IM9, IM86, IM87 & IM99.

*** Second Class, Economy and Economy Deferred letters and large letters will be delivered 5 days per week on alternate weekdays (Monday to Friday).

Unsorted Product Options.

- Not machine-readable

There are no restrictions in terms of design, but the items must meet the address and data standards as detailed in the paragraph on customer data- improving targeting, above.

- Machine-readable

Royal Mail Mailmark® option – this option is for letters and large letters and offers Batch level reporting. This requires a Mailmark barcode to be applied to each item. There are fewer design and presentation constraints with Mailmark barcodes. The Mailmark barcode is unique to the mail piece and contains data (e.g., sender, recipient, postcode, mail piece & characteristics) encoded within it. There are two types of Mailmark barcode:

1. a 2D data matrix Mailmark barcode
2. a 4-state Mailmark barcode

Account – this requires a printed postage impression that contains a barcode. Full details can be found in the Account User Guide.

Advanced – this requires a licence number and licence barcode or a printed postage impression that contains a barcode. Full details can be found in the following section of this user guide.

Machine-readable Advanced

Machine readable Advanced is available through an account with Royal Mail. Advanced items that are highly machinable are priced below items that are not highly machinable. All letter and large letter items should be posted as either Advertising Advanced when the minimum posting volume is achieved or Business Mail Advanced for postings below the minimum posting volume. The same licence and barcodes can be used for Advertising and Business Mail postings with one stationery design for 1st class letter and large letter items and 1 design for 2nd class letter and large letter items. The Advanced and Account products cannot be used with the same barcode or on the same account with Royal Mail.

Advanced account mail pieces

The barcodes you are supplied for the advanced product must be used on all your unsorted letter and large letter postings.

There are two options for Advanced items posted on account.

1. The existing option where items have a licence number and licence barcode printed on them in addition to an address and a printed postage impression. The licence number contains three lines of text stating the name of the service, class and 12 alpha character licence number with the licence barcode printed beneath the licence number. The licence and licence barcode should be used with one stationery design for 1st Class letter and large letter items and 1 design for 2nd class letter and large letter items for a single account at a single site. To assist the production of your mail pieces an artwork generator is available on our web site at the following address www.royalmail.com/licence. An image of the licence number and licence barcode and technical drawings are illustrated below.

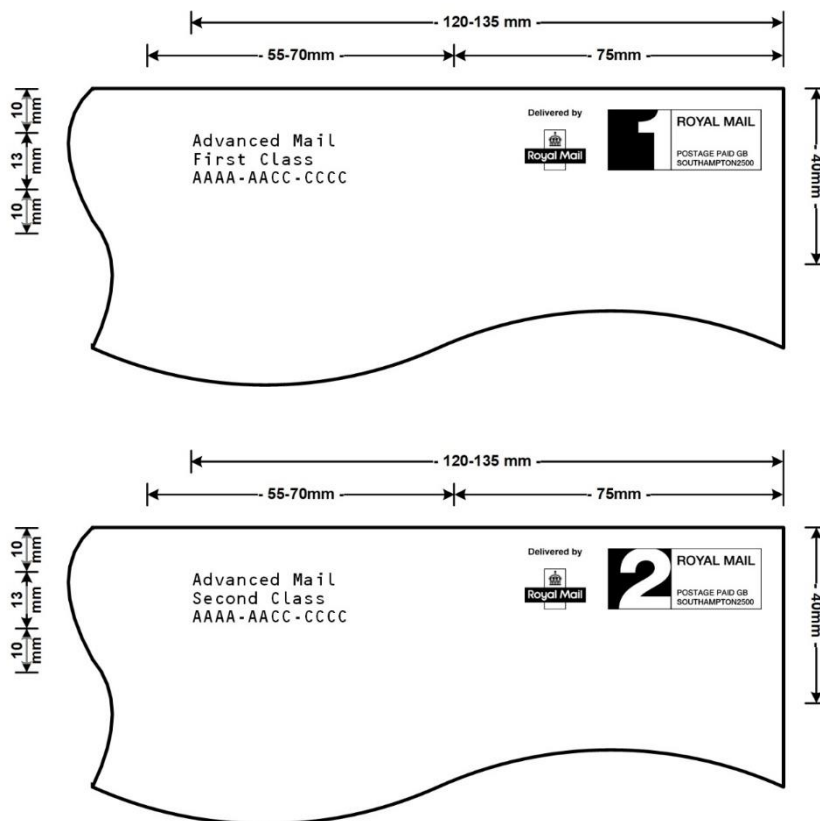

2. A new option where items have a barcode contained in the new printed postage impression and an address on the item. You must apply for this new type of barcode. The new 4 state barcode should be used with one stationery design for 1st Class letter and large letter items and 1 design for 2nd Class letter and large letter items for a single account at a single site. To assist the production of your mail pieces an artwork generator is available on our web site at the following address www.royalmail.com/artwork. The artwork generator provides EPS Vector files that provide the best quality mail pieces and support professional printing and J peg files. An image of the printed postage impression including a 4-state barcode and technical are illustrated on the next page.

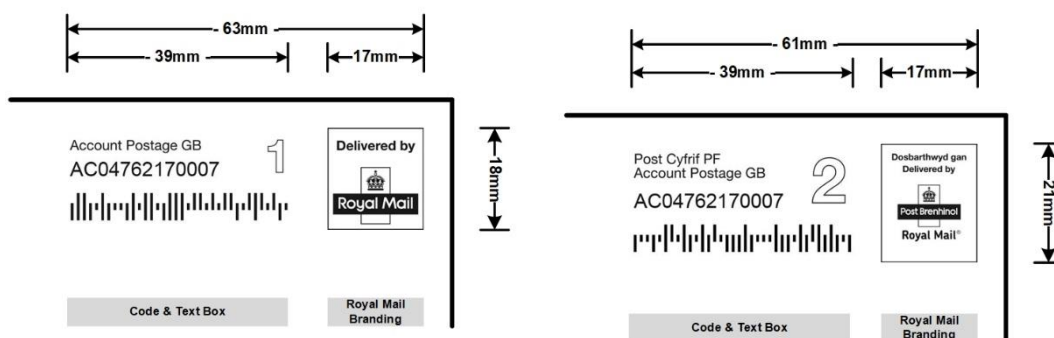

Posting Advanced items on account

Minimum volumes of 1,000 letters per class per sales order and 250 large letters per class per sales are required to post Advertising items.

Advertising 1st Class letter and large letter item details including the average weight must be recorded on an online business accounting sales order with the UNK product code. Advertising 2nd Class Letter and large letter item details including the average weight must be recorded on an online business accounting sales order with the UNL product code. The sales order must be confirmed before posting. The items must be presented in trays for collection by Royal Mail or delivered to an agreed Royal Mail acceptance point.

Advanced Account billing and adjustments

The details you record on your online business accounting sales orders will be billed at the published rate card prices that may include volume related discounts. Additionally, for postings made each week (Monday to Saturday) you may be retrospectively billed an adjustment fee for any items that are not highly machinable determined by our automation. You may also be retrospectively billed for any volume variances between the weekly totals recorded on your sales orders and the volumes received by Royal Mail. Please see our rate cards for the published adjustment fees. Any such adjustments will appear on your invoice (s) with the following descriptions:

Type of adjustment	Format	Class	Description on invoice
Items with no barcode read	Letter	1 st	Barcode not seen letter 1c
Items with no barcode read	Letter	2 nd	Barcode not seen letter 2c
Items with no barcode read	Large Letter	1 st	Barcode not seen large letter 1c
Items with no barcode read	Large Letter	2 nd	Barcode not seen large letter 2c
Items not declared on Sales Orders	Letter	1 st	Letters undeclared 1c
Items not declared on Sales Orders	Letter	2 nd	Letters undeclared 2c
Items not declared on Sales Orders	Large Letter	1 st	Large letters undeclared 1c
Items not declared on Sales Orders	Large Letter	2 nd	Large letters undeclared 1c
Out of spec * (product is Letter and Large Letter only)	Parcel	NA	Incorrect Format-LL = P (T)
Items not declared on Sales Orders (International destinations)	Letter or Large Letter	NA	Intl letter undeclared Intl large letter undeclared

*The out of spec (Product is only Letters and Large Letters) charge is for items that are either greater than the maximum dimensions of a large letter or greater than the maximum weight of a Large Letter.

Please note the following requirements in relation to machine-readable items:

The maximum size for a machine-readable large letter is smaller than a non-machine-readable large letter, due to sorting machinery and tray constraints

- you will find full details of minimum sizes in the Machine-readable letters and large letters sections of the user guide
- you will find full details of the technical requirements for using Mailmark barcodes in the 'Mailmark Machine-readable letters and large letters' section of the User Guide
- you will find full details of the technical requirements in the 'Machine-readable letters and large letters' section of the User Guide for Marketing, Publishing and General Correspondence Products www.royalmailtechnical.com
- The accreditation process for the various machine-readable options is also detailed at the same location.

Sorted Options

Volumes

- letters – minimum 4,000
- large letters – minimum 1,000

Delivery speed choices

- 1st Class: we aim to deliver on the next working day after the day of posting*
- 2nd Class: we aim to deliver within three working days after the day of posting**
- Economy: we aim to deliver within six working days after the day of posting**
- Economy deferred: we aim to deliver within six working days after a date stipulated by you, up to twenty-eight days after posting**

* Exclusions: Postcodes: PH19 – 50, ZE1, ZE2 & ZE3, HS1-5, HS6, HS7-8 & HS9, KW16, KW15, KW17, JE1 – JE4 and IM1 - IM9, IM86, IM87 & IM99.

** Second Class, Economy and Economy Deferred letters and large letters will be delivered 5 days per week on alternate weekdays (Monday to Friday).

Format and weight:

Product Option	Format	Weight
Low Sort	Letter (up to 240mm x 165mm x 5mm) Large Letter (up to 345mm x 245mm x 13mm)	max 100g max 750g
Low sort Manual	Letter (up to 240mm x 165mm x 5mm) Large Letter (up to 345mm x 245mm x 13mm)	max 100g max 750g

Low Sort options:

- Low Sort with Mailmark option - this option is for letters and large letters and offers Batch level reporting. This requires a Mailmark barcode to be applied to each item. There are fewer design and presentation constraints with Mailmark barcodes. The Mailmark barcode is unique to the mail piece and contains data (e.g., Sender, recipient, postcode, and mail piece characteristics) encoded within it. There are two types of Mailmark barcode:
 1. a 2D data matrix Mailmark barcode
 2. a 4-state Mailmark barcode
- Low Sort Manual - there are some design and presentation constraints. Variations of this specification are available for letters and large letters. It does not offer reporting.

General Information

We want to provide you with the best possible service when using our Advertising Mail products, so mailings are received by customers in great condition. However, mail is a physical medium and occasionally indentations or marking of mail may occur as it passes through machinery. This applies particularly with unwrapped mail that has been produced printed mail items are wrapped, or an ultra-violet (UV) or water-based gloss coating applied to the non-address side of the finished piece. These coatings enhance wear resistance. Mail produced on lithograph presses is less susceptible to this type of marking.

Audit Procedure

Audit after Posting.

If, during or following an audit of your mailings, we reasonably believe that you have not complied and/or cannot comply fully with the Advertising Mail terms & conditions (for example the advertising content or data recency requirements), we will be entitled to:

- suspend your ability to send Advertising Mail until such time as we are satisfied of your ability to comply with the necessary terms and conditions, and/or terminate our Advertising Mail agreement with you

Where we have identified that you have not fully complied with the requirements of Advertising Mail in respect of specific posting(s) where you have benefited from the Advertising Mail rates, we may require you to pay us a sum equal to the difference between the aggregate Advertising Mail postage rate paid as part of such posting(s) and the appropriate charge that you would have had to pay us for the equivalent Business 1st Class or Business Class posting(s) that do not qualify as Advertising Mail, as well as our reasonable costs and expenses incurred in carrying out the audit and calculating any amount due from you.

Additional information on all products and specifications are available at;
www.royalmailtechnical.com Helpline: **020 7371 6957**

End Notes

Low Sort – Requires you to sort the mail prior to dispatch into 86 segregations, details are available on www.royalmail.comⁱⁱ